

## Louis

Braccioli sagomati con un taglio obliquo caratterizzano la collezione e, grazie al cuscino di seduta intero, l'immagine complessiva risulta morbida ma sofisticata. La possibilità di giocare con la combinazione di elementi con diverse profondità permette composizioni eclettiche e versatili.

Contoured armrests with an oblique cut are the characteristics of this collection and, thanks to the seat cushions, the total look results both softer and sophisticated. The possibility to play with its various elements with different depths allows to have versatile and eclectic combinations.

108, 109

LOUIS SMALL divano componibile  
. modular sofa, cuscini . cushions 50CF  
BONGO tavolo basso . low table  
JILL poltroncina . small armchair

P. 109 LOUIS PLUS divano componibile  
. modular sofa, cuscini . cushions 50CF  
BELT TB40 tavolo basso . low table



110, 111



LOUIS PLUS 2007

elemento - unit PLUS 105

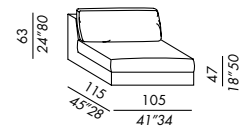

elemento - unit PLUS 160

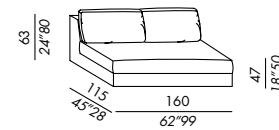

angolo - corner PLUS 115

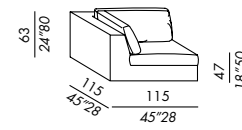

terminale - end unit PLUS 115

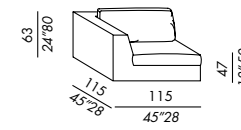

terminale - end unit PLUS 130 \*

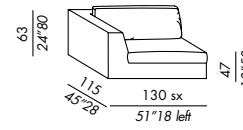

terminale - end unit PLUS 160 \*

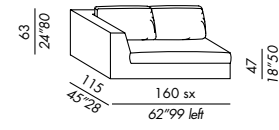

terminale - end unit PLUS 190 \*

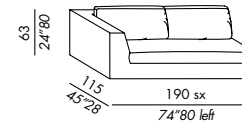

chaise longue PLUS

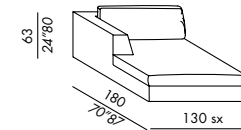

elemento penisola - peninsula unit PLUS 230

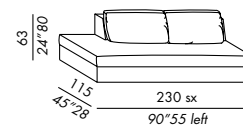

angolo penisola - peninsula corner unit PLUS 250

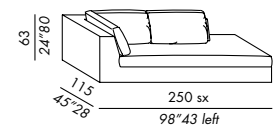

pouf PLUS 105

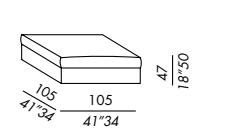

pouf PLUS 115

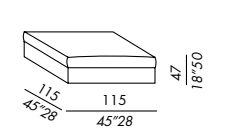

cuscinò bracciolo - arm cushion PLUS

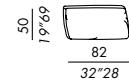

TECHNICAL DETAILS

IT

- divani ed elementi componibili sfoderabili
- fissi per versione in pelle
- struttura in legno
- imbottitura in poliuretano indeformabile
- piedini neri in ABS
- staffe in metallo per fissaggio elementi
- cuscino seduta in poliuretano e piuma supportata
- cuscino schienale in piuma supportata
- cuscino bracciolo in piuma supportata - optional

EN

- sofas and modular units with removable covers
- fixed cover for leather version
- wooden frame
- non-deformable polyurethane padding
- black ABS feet
- metal brackets for modular units joining
- seat cushion in polyurethane and reinforced feathers
- back cushion in reinforced feathers
- arm cushion in reinforced feathers - optional

DE

- Abziehbare Sofas und Anbauelemente
- Fester Lederbezug
- Holzgestell
- Polsterung aus unverformbaren PU-Schäumen
- FüÙe ABS Schwarz
- Metallverbindungen zur Befestigung der Anbauelemente
- Sitzkissen PU-Schäume und Abdeckung Polyesterdaune
- Rückenissen Polyesterdaunen
- Armkissen Polyesterdaunen - optional

FR

- canapés et éléments modulables déhoussables
- fixes pour version en cuir
- structure en bois
- rembourrage en polyuréthane indéformable
- pieds noirs en ABS
- plaques en métal pour fixation des éléments
- coussin assise en polyuréthane et plumes renforcées
- coussin dos en plumes renforcées
- coussin accoudoir en plumes renforcées - optioneel

ES

- sofà elementos modulares desenfundables
- revestimiento fijo para versión en piel
- estructura de madera
- relleno en poliuretano indeformable
- patas negras en ABS
- abrazaderas en metal para fijar elementos
- cojín asiento en poliuretano y pluma soportada
- cojín respaldo en pluma soportada
- cojín brazo en pluma soportada - opcional

- I modelli **Small e Plus** sono componibili tra loro

- The **Small and Plus** models may be used together

- Die Module **Small and Plus** sind untereinander kombinierbar

- Les modèles **Small et Plus** sont modulaires entre eux

- Los modelos **Small y Plus** son modulares entre sí

- **divano letto** con rete in metallo elettrosaldata
- materasso in poliuretano e fibra anallergica

- **sofabed** with metal electric-welded base
- mattress in polyurethane and anallergic fibre

- **Sofabett** mit ausfaltbarem Metall-Matratzenrahmen
- Matratze aus antiallergischen PU-Schäumen

- **canapé-lit** avec sommier en métal électro soudé
- matelas en polyuréthane et fibre anallergique

- **sofá-cama** con somier en metal electrosoldado
- colchón en poliuretano y fibra no alérgica

SKETCHES OF CONFIGURATIONS

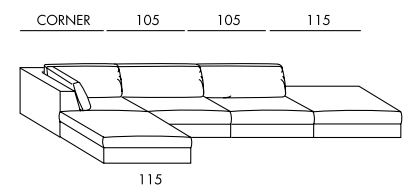
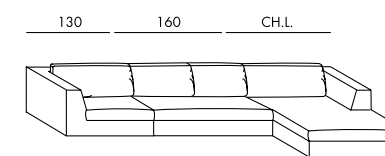
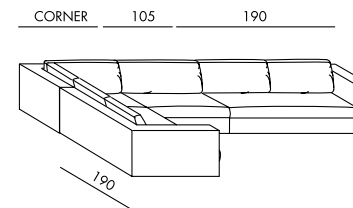
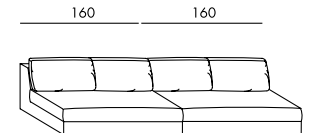
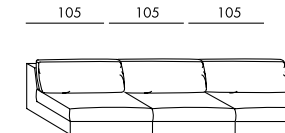
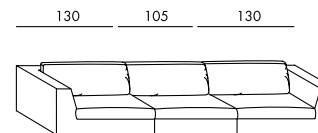
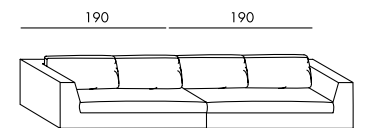
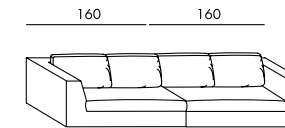
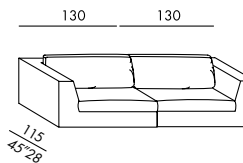

\* se usato come angolo aggiungere cuscino bracciolo  
in case the unit is used as a corner, add the armrest cushion



114, 115



LOUIS SMALL divano componibile . modular sofa  
cuscini . cushions 50CF, ADRIAN 50R, 55 tavoli bassi . low tables





116, 117

LOUIS SMALL divano componibile . modular sofa  
LOUIS poggiatesta rullo . headrest roll



118, 119



LOUIS SMALL, LOUIS PLUS  
divano componibile . modular sofa  
cuscini . cushions 42CS, 50CS  
HARDY QUATTRO 40, HARDY UNO  
tavoli bassi . low tables  
FARRELL pouf

LOUIS SMALL 2007

sofa SMALL 180

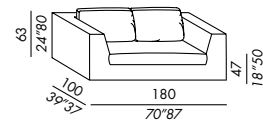

sofa SMALL 220

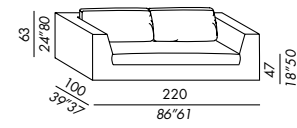

sofa SMALL 240

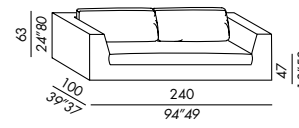

sofa SMALL 260

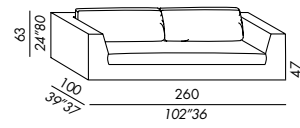

chaise longue SMALL

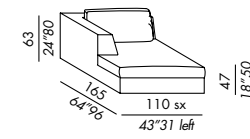

cuscino bracciolo - arm cushion SMALL

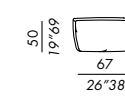

poggiatesta rullo - headrest roll

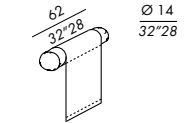

pouf SMALL 85

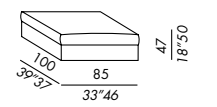

pouf SMALL 100

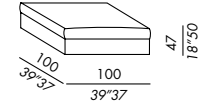

divano letto - sofa bed SMALL

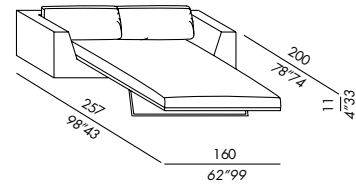

elemento - unit SMALL 85

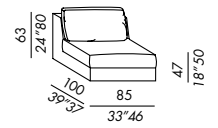

SKETCHES OF CONFIGURATIONS

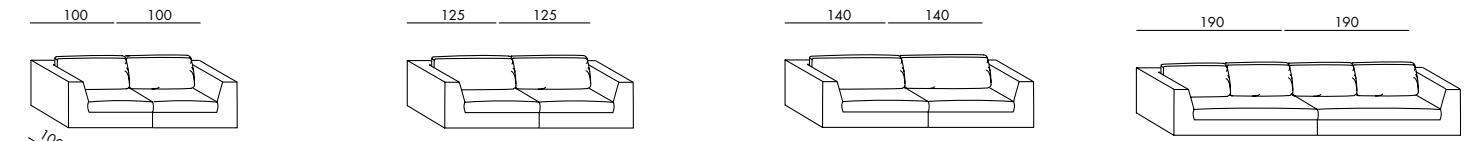

elemento - unit SMALL 100

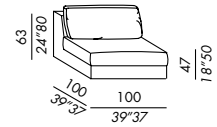

elemento - unit SMALL 170

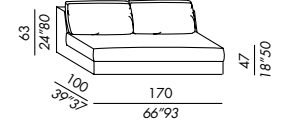

elemento laterale - side unit SMALL 100

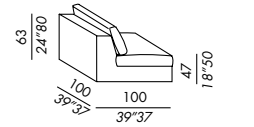

angolo - corner SMALL 100

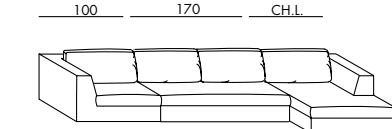
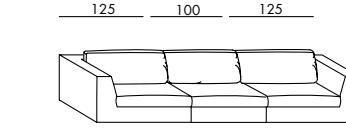
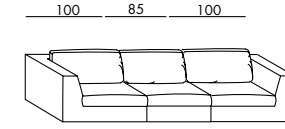
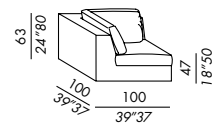

120, 121

angolo - corner SMALL 115

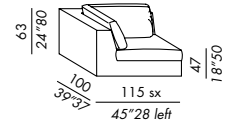

terminale - end unit SMALL 100

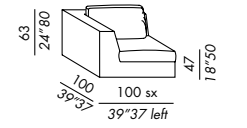

terminale - end unit SMALL 115

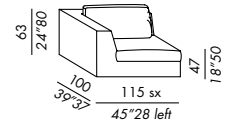

terminale - end unit SMALL 125 \*

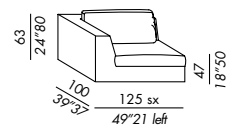

SKETCHES OF CONFIGURATIONS SMALL + PLUS

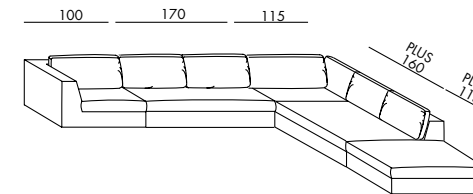

terminale - end unit SMALL 140 \*

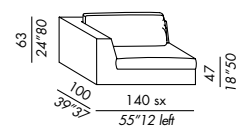

terminale - end unit SMALL 190 \*

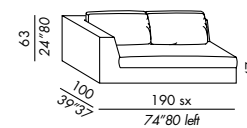

elemento penisola - penisola unit SMALL 230

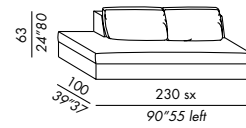

angolo penisola - penisola corner unit SMALL 250

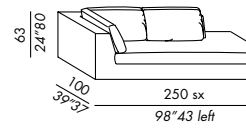

\* se usato come angolo aggiungere cuscino bracciolo in case the unit is used as a corner, add the armrest cushion

## Harold, Louis vassoio-tasca tray-pocket

Un nuovo accessorio per i divani dal fascino intramontabile Louis e Harold:  
un vassoio in legno di rovere o in lacca con sella in cuoio dotata di tasche lisce o intrecciate,  
da posizionare liberamente sui pouf, come portaoggetti e portariviste.

A new accessory for Louis and Harold sofas with a timeless charm: a tray in oak  
wood or lacquer with saddle-leather with smooth or woven pockets, to be freely  
placed on the ottomans, as a storage piece or magazine holder.

48, 49







50, 51



LOUIS pouf plus 115 and tray-pocket B-B  
LOUIS divano . sofa

**TECHNICAL DETAILS**

**IT**

- vassoio in legno con sella-tasca in cuoio per pouf
- finiture vassoio: impiallacciatura rovere tinto - impiallacciatura rovere tinto con pianetto interno in vetro retroverniciato - lacca opaca o lucida con pianetto interno in vetro retroverniciato
- sella in cuoio con tasche lisce o intrecciate
- vite a cannocchiale in metallo

**EN**

- wooden tray with saddle-pocket in saddle leather for pouf
- tray finishes: stained oak veneer - stained oak veneer with inner top in back-painted glass - matt or glossy lacquer with inner top in back-painted glass
- saddle with plain or woven saddle leather pockets
- sex bolts

**DE**

- Holztafeltt mit Sattel-Tasche aus Kernleder für Hocker
- Tablettausführungen: Eiche Furnier - Eiche Furnier mit interner Platte aus Hochglanz mit interner Platte aus rücklackiertem Glas
- Sattel mit Taschen aus glatten oder geflochten Kernleder
- Metallbuchschaube

**FR**

- plateau en bois avec selle - poche en cuir sellier pour pouf
- finitions plateau: placage de chêne teinté - placage de chêne teinté avec plateau intérieur en verre retro-laqué - laque mate ou avec plateau intérieur en verre retro-laqué
- selle en cuir sellier avec poches lisses ou tressés
- vis de rappel en métal

**ES**

- bandeja de madera con silla-bolsa en cuero para pouf
- acabados bandeja: enchapado en roble teñido - enchapado en roble teñido con sobre interior en vidrio retrobarnizado - lacado mate o brillo con sobre interior en vidrio retrobarnizado
- silla en cuero con bolsillos lisos o entretejidos
- tornillo telescópico en metal

**finiture**

- vedi campionario

**finishes**

- see sample box

**Ausführungen**

- siehe Musterbox

**finitions**

- voir boîte d'échantillons

**acabados**

- véase el muestrario

**IT**

- vassoio in legno con sella-tasca in cuoio per pouf
- finiture vassoio: impiallacciatura rovere tinto - impiallacciatura rovere tinto con pianetto interno in vetro retroverniciato - lacca opaca o lucida con pianetto interno in vetro retroverniciato
- sella in cuoio con tasche lisce o intrecciate
- vite a cannocchiale in metallo

**EN**

- wooden tray with saddle-pocket in saddle leather for pouf
- tray finishes: stained oak veneer - stained oak veneer with inner top in back-painted glass - matt or glossy lacquer with inner top in back-painted glass
- saddle with plain or woven saddle leather pockets
- sex bolts

**DE**

- Holztafeltt mit Sattel-Tasche aus Kernleder für Hocker
- Tablettausführungen: Eiche Furnier - Eiche Furnier mit interner Platte aus Hochglanz mit interner Platte aus rücklackiertem Glas
- Sattel mit Taschen aus glatten oder geflochten Kernleder
- Metallbuchschaube

**FR**

- plateau en bois avec selle - poche en cuir sellier pour pouf
- finitions plateau: placage de chêne teinté - placage de chêne teinté avec plateau intérieur en verre retro-laqué - laque mate ou avec plateau intérieur en verre retro-laqué
- selle en cuir sellier avec poches lisses ou tressés
- vis de rappel en métal

**ES**

- bandeja de madera con silla-bolsa en cuero para pouf
- acabados bandeja: enchapado en roble teñido - enchapado en roble teñido con sobre interior en vidrio retrobarnizado - lacado mate o brillo con sobre interior en vidrio retrobarnizado
- silla en cuero con bolsillos lisos o entretejidos
- tornillo telescópico en metal

**finiture**

- vedi campionario

**finishes**

- see sample box

**Ausführungen**

- siehe Musterbox

**finitions**

- voir boîte d'échantillons

**acabados**

- véase el muestrario

vassoio tasca - tray/pocket A-A

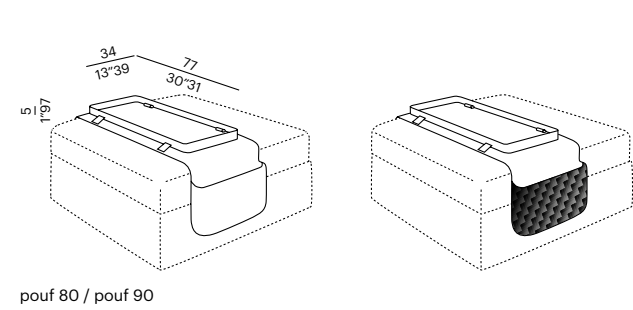

vassoio tasca - tray/pocket B-B

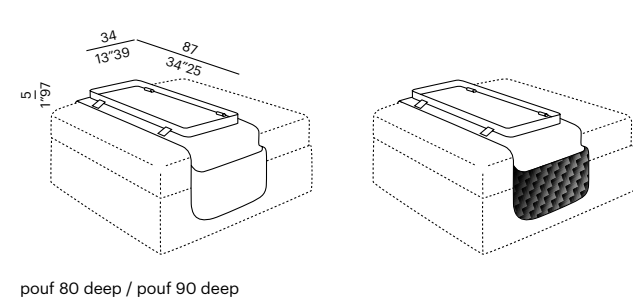

vassoio tasca - tray/pocket A-A

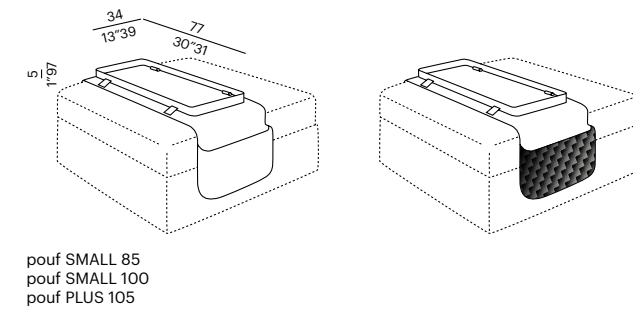

vassoio tasca - tray/pocket B-B

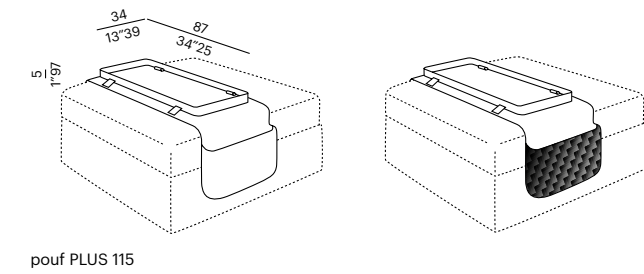

poggiatesta rullo - headrest roll

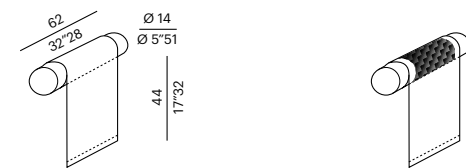

vassoio tasca - tray/pocket C-C1

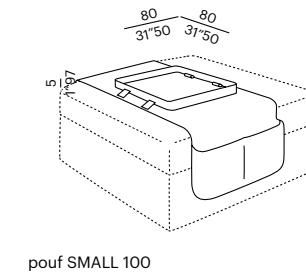

vassoio tasca - tray/pocket C-C2

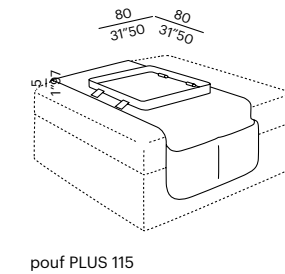

poggiatesta rullo - headrest roll

