

Designer
Pianca Studio

Vista



Il sistema di chiusura Vista si caratterizza per la totale assenza di telai o per il sottile profilo perimetrale e modularità al centimetro, per dividere ed unire gli spazi allo stesso tempo.

EN The major features of the sliding door Vista are the total lack of frames or the very thin perimetral profile and it's modularity to the centimeter, in order to separate or join spaces.

Info tecniche

EN Technical info

Il sistema di chiusura Vista si caratterizza per la totale assenza di telai e per la modularità al millimetro. Binari e ante vengono sempre realizzati su misura,

^{EN} A characteristic of the Vista door system is the absence of frames and the extremely wide modularity. Rails and doors are always made to measure

Binario monorotaia

^{EN} Single track

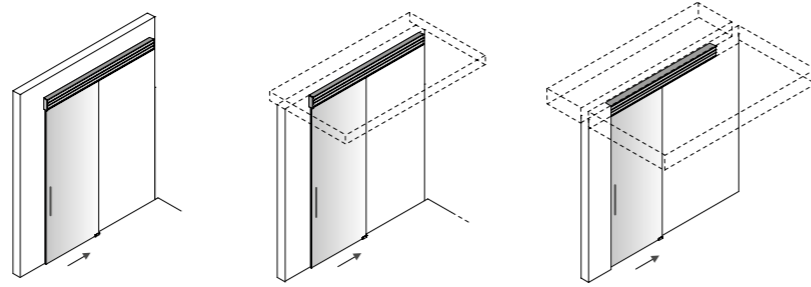

A parete,
^{EN} Wall mounted

L min 135 max 600 cm
W min 53.15" max 236.22"

A soffitto,
^{EN} Ceiling mounted

L min 135 max 600 cm
W min 53.15" max 236.22"

Ad incasso,
^{EN} Recessed

L min 135 max 600 cm
W min 53.15" max 236.22"

Binario monorotaia + pannello fisso

^{EN} Single track + fixed panel

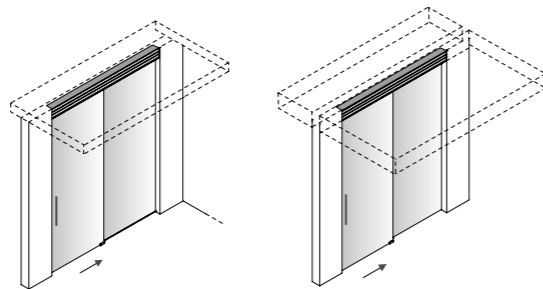

A soffitto,
^{EN} Ceiling mounted

L min 138 max 600 cm
W min 54.33" max 236.22"

Ad incasso,
^{EN} Recessed

L min 138 max 600 cm
W min 54.33" max 236.22"

PIANCA

Sistemi Notte
^{EN} Night Systems

Binario birotaia

^{EN} Double track

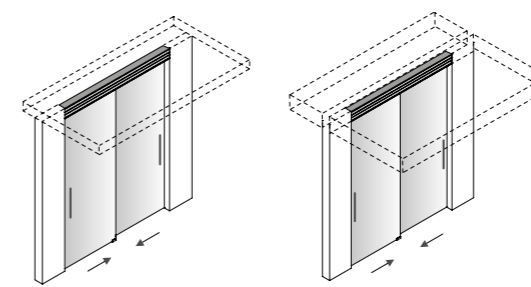

A soffitto,
^{EN} Ceiling mounted

L min 138 max 600 cm
W min 54.33" max 236.22"

Ad incasso,
^{EN} Recessed

L min 138 max 600 cm
W min 54.33" max 236.22"

Pannelli fissi divisori

^{EN} Fixed panels dividers

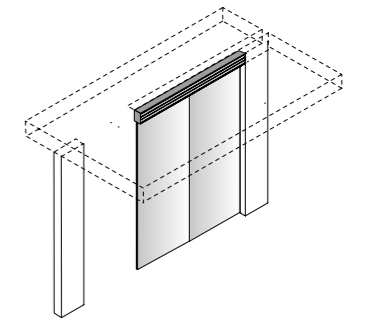

Pannello fisso divisorio,
^{EN} Fixed panel divider

L min 70 max 600 cm
W min 27.56" max 236.22"

Angolari

^{EN} Corner

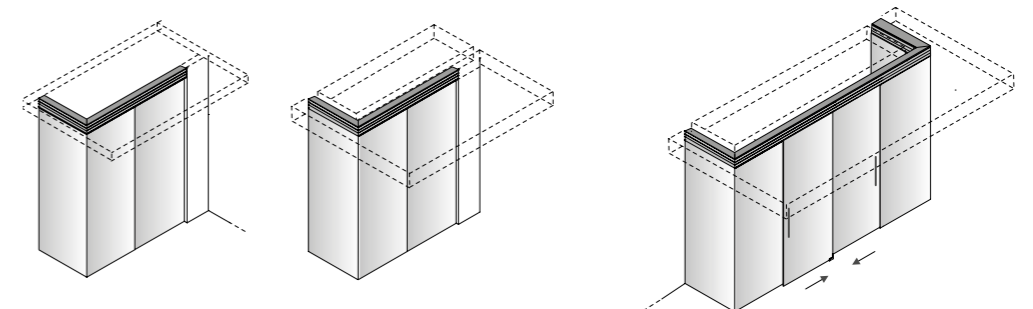

Pannello fisso soffitto,
^{EN} Ceiling mounted fixed panel

L min 70 max 600 cm
W min 27.56" max 236.22"

Pannello fisso ad incasso,
^{EN} Recessed fixed panel

L min 70 max 600 cm
W min 27.56" max 236.22"

2 pannelli fissi e 2 ante su binario birotaia a soffitto,
^{EN} 2 fixed panels and 2 doors on recessed double track

L min 70 max 600 cm
W min 27.56" max 236.22"

Vista con anta Crystal

EN Vista with Crystal door

Finiture

EN Finishes

Finiture anta,

EN Door finishes

Vetro Laccato Opaco o Lucido, EN Matt or Glossy Lacquered Glass

Vetro, EN Glass: Trasparente, Trama

Finiture Binario,

EN Track Finishes

Alluminio Anodizzato o pitturabile con tempere murarie, EN Anodised or paintable aluminum

Maniglie

EN Handles

Con Gola, EN With groove

U40

Finiture Metallo Opaco o Lucido, EN Matt or Glossy Metal Finishes: Champagne, Bronzo, Cromo, Titanio

Laccato Opaco, EN Matt Lacquered



PIANCA

Sistemi Notte
EN Night Systems

Modularità

EN Modularity

L da 70 a 120 cm
H da 190 a 280 cm

W from 27.56" to 47.24"
H from 74.80" to 110.24"

Pannello fisso,

EN Fixed panel

L da 70 a 120 cm
H da 190 a 280 cm

W from 27.56" to 47.24"
H from 74.80" to 110.24"

Binario di scorrimento,

EN Track

L max 600 cm
W max 236.22"

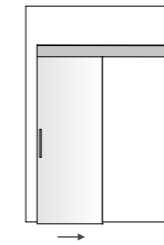

Anta scorrevole con binario a parete,

EN Sliding door with wall mounted track

Dimensione vano, EN Opening:

L da 68 a 118 cm
H da 186 a 276 cm

W from 26.77" to 46.46"
H from 73.22" to 108.66"

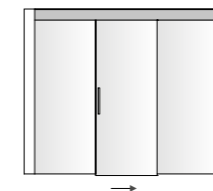

Anta scorrevole e 2 pannelli fissi binario a soffitto,

EN Door and 2 fixed panels on a ceiling mounted track

Dimensione vano, EN Opening:

L da 206 a 356 cm
H da 199 a 289 cm

W from 81.10" to 140.16"
H from 78.35" to 113.78"

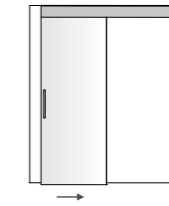

Anta scorrevole con binario a soffitto,

EN Sliding door with ceiling mounted track

Dimensione vano, EN Opening:

L da 68 a 118 cm
H da 199 a 289 cm

W from 26.77" to 46.46"
H from 78.35" to 113.78"

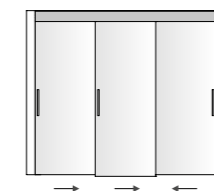

3 ante scorrevoli con binario a soffitto,

EN 3 sliding doors with ceiling mounted track

Dimensione vano, EN Opening:

L da 206 a 356 cm
H da 199 a 289 cm

W from 81.10" to 140.16"
H from 78.35" to 113.78"

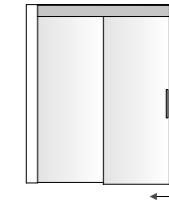

Anta scorrevole e pannello fisso con binario a soffitto,

EN Door and fixed panel on ceiling mounted track

Dimensione vano, EN Opening:

L da 138 a 238 cm
H da 199 a 289 cm

W from 54.33" to 93.70"
H from 78.35" to 113.78"

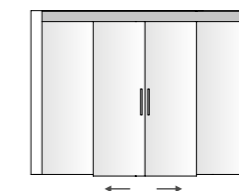

2 ante scorrevoli e 2 pannelli fissi binario a soffitto,

EN 2 sliding doors and 2 fixed panels on a ceiling mounted track

Dimensione vano, EN Opening:

L da 276 a 476 cm
H da 199 a 289 cm

W from 108.66" to 187.40"
H from 78.35" to 113.78"



2 ante scorrevoli con binario a soffitto,

EN 2 sliding doors with ceiling mounted track

Dimensione vano, EN Opening:

L da 138 a 238 cm
H da 199 a 289 cm

W from 54.33" to 93.70"
H from 78.35" to 113.78"

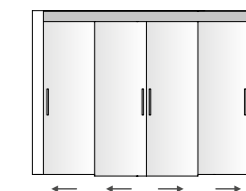

4 ante scorrevoli binario a soffitto,

EN 4 sliding doors on a ceiling mounted track

Dimensione vano, EN Opening:

L da 276 a 476 cm
H da 199 a 289 cm

W from 108.66" to 187.40"
H from 78.35" to 113.78"

Vista con anta Plana

EN Vista with Plana door

Finiture EN Finishes

Finiture anta, EN Door finishes

Laccato Opaco o Lucido,
EN Matt or High Gloss
Lacquered,

Essenza, EN Wood:
Borgogna, Canaletto,
Rovere Fumo, Rovere
Grigio, Rovere Laguna
Rovere Naturale, Rovere
Tabacco

Materico: Bianco, Genere,
Seta, Alaska, Corsica

Pitturabile con tempere
murarie, EN Paintable

Finiture Binario, EN Track Finishes

Alluminio Anodizzato o
pitturabile con tempere
murarie, EN Anodised
aluminum, paintable
aluminum

Maniglie EN Handles

U40

Finiture Metallo Opaco o
Lucido, EN Matt or Glossy
Metal Finishes:
Champagne, Bronzo,
Cromo, Titanio

Laccato Opaco,
EN Matt Lacquered



Modularità EN Modularity

L da 70 a 120 cm
H da 190 a 280 cm

W from 27.56" to 47.24"
H from 74.80" to 110.24"

Pannello fisso, EN Fixed panel

L da 70 a 120 cm
H da 190 a 280 cm

W from 27.56" to 47.24"
H from 74.80" to 110.24"

Binario di scorrimento, EN Track

L max 600 cm
W max 236.22"

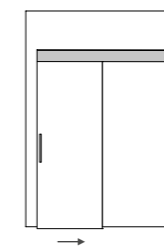

Anta scorrevole con binario a parete, EN Sliding door with wall mounted track

Dimensione vano,
EN Opening:

L da 68 a 118 cm
H da 186 a 276 cm

W from 26.77" to 46.46"
H from 73.22" to 108.66"

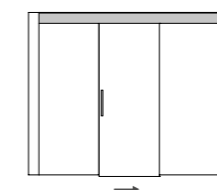

3 ante scorrevoli con binario a soffitto, EN 3 sliding doors with ceiling mounted track

Dimensione vano,
EN Opening:

L da 206 a 356 cm
H da 199 a 289 cm

W from 81.10" to 140.16"
H from 78.35" to 113.78"

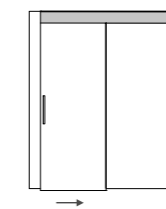

Anta scorrevole con binario a soffitto, EN Sliding door with ceiling mounted track

Dimensione vano,
EN Opening:

L da 68 a 118 cm
H da 199 a 289 cm

W from 26.77" to 46.46"
H from 78.35" to 113.78"

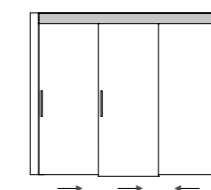

Anta scorrevole e 2 pannelli fissi binario a soffitto, EN Sliding doors and 2 fixed panels on a ceiling mounted track

Dimensione vano,
EN Opening:

L da 206 a 356 cm
H da 199 a 289 cm

W from 81.10" to 140.16"
H from 78.35" to 113.78"

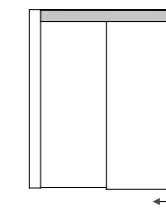

Anta scorrevole e pannello fisso con binario a soffitto, EN Sliding door and fixed panel on ceiling mounted track

Dimensione vano,
EN Opening:

L da 138 a 238 cm
H da 199 a 289 cm

W from 54.33" to 93.70"
H from 78.35" to 113.78"

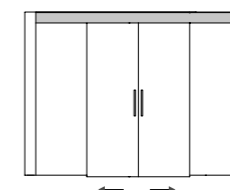

2 ante scorrevoli e 2 pannelli fissi binario a soffitto, EN 2 sliding doors and 2 fixed panels on a ceiling mounted track

Dimensione vano,
EN Opening:

L da 276 a 476 cm
H da 199 a 289 cm

W from 108.66" to 187.40"
H from 78.35" to 113.78"

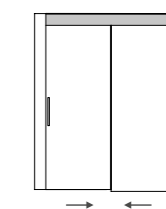

2 ante scorrevoli con binario a soffitto, EN 2 sliding doors with ceiling mounted track

Dimensione vano,
EN Opening:

L da 138 a 238 cm
H da 199 a 289 cm

W from 54.33" to 93.70"
H from 78.35" to 113.78"

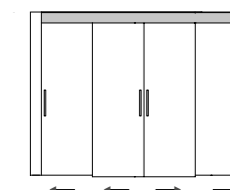

4 ante scorrevoli binario a soffitto, EN 4 sliding doors on a ceiling mounted track

Dimensione vano,
EN Opening:

L da 276 a 476 cm
H da 199 a 289 cm

W from 108.66" to 187.40"
H from 78.35" to 113.78"