

TECHNICAL DATA

ROLF BENZ MOYO



**ROLF
BENZ**

- Wooden inner frame
- Nosag spring support
- Seat made of high-quality cold foam, covered with a down-like pad comprising compartments with a filling made of foam rods and polyester fibres
- Backrest made of polyurethane foam, covered with a down-like pad comprising compartments with a filling made of foam rods and polyester fibres.
- Seat height options 43 cm or 45 cm

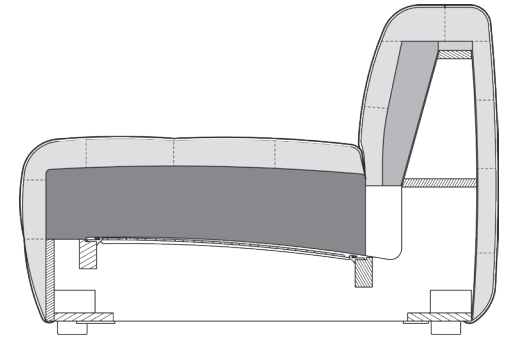

! A high-quality, especially casual upholstery that forms waves/leaves indentations that are typical of the material - this waviness may even occur in new condition. All dimensions are approximate and may deviate by up to around 4 cm, or even more in individual cases where elements are connected.

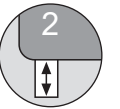

Sofa, side element low or high

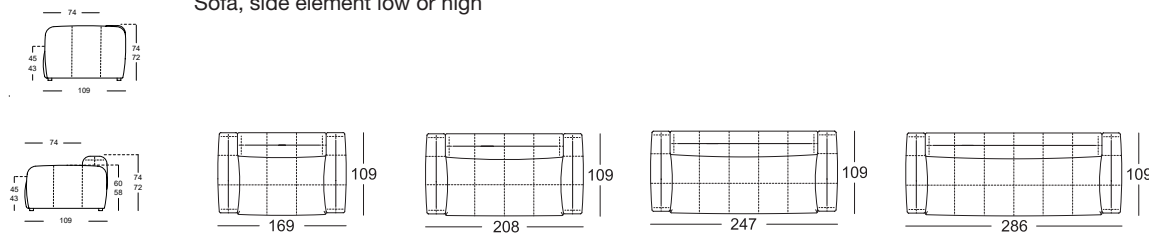

**ROLF
BENZ**

Sectional sofa side element low or high*

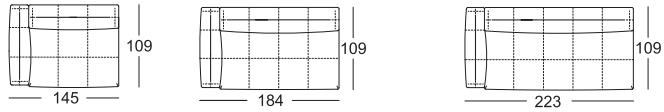

Outsize closing chair with fixed footstool side element low or high*

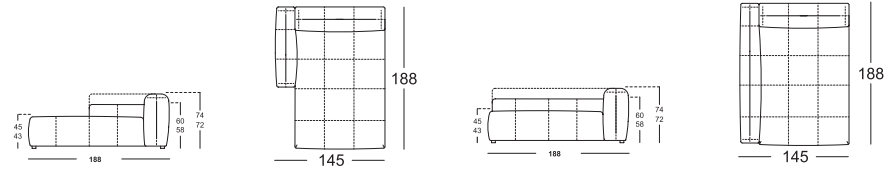

Outsize sectional sofa with fixed footstool side element low or high*

Extra deep sectional sofa side element low or high*

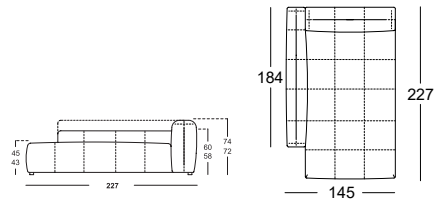

Corner modular element side element low or high*

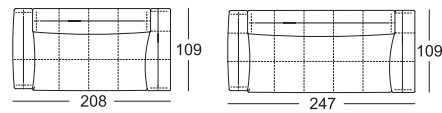

Sectional sofa*

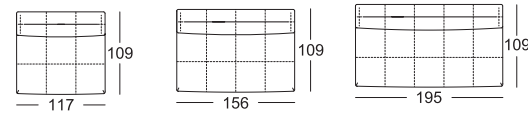

Corner sectional sofa*

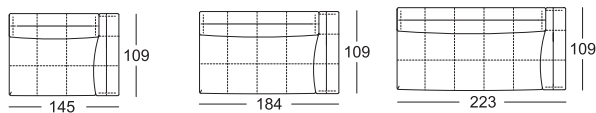

Upholstered bench element

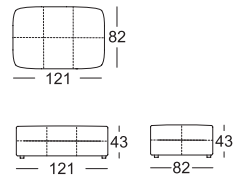

Sectional bench element

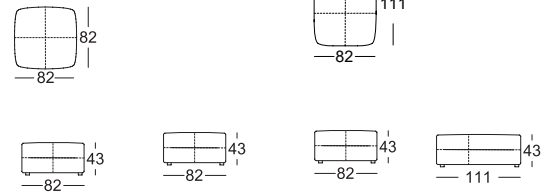

Piped back cushion
with roll

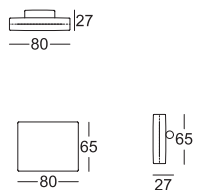

Piped back cushion

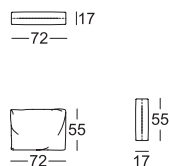

Piped back cushion mat

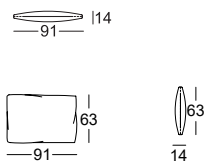

Combination examples:

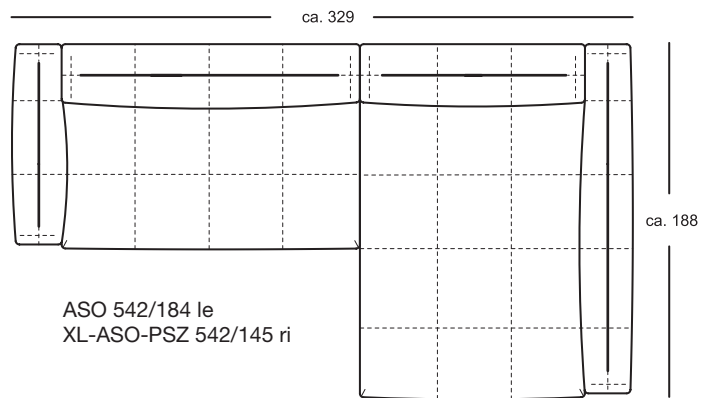
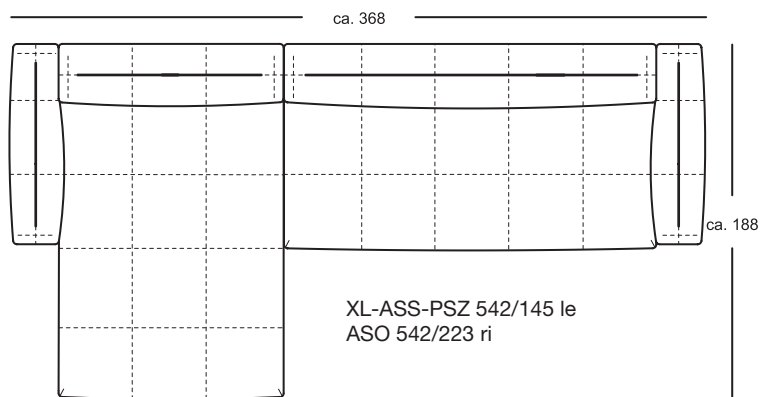

Combination examples:

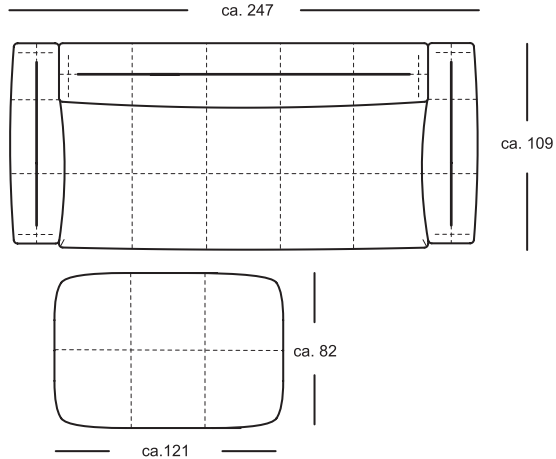
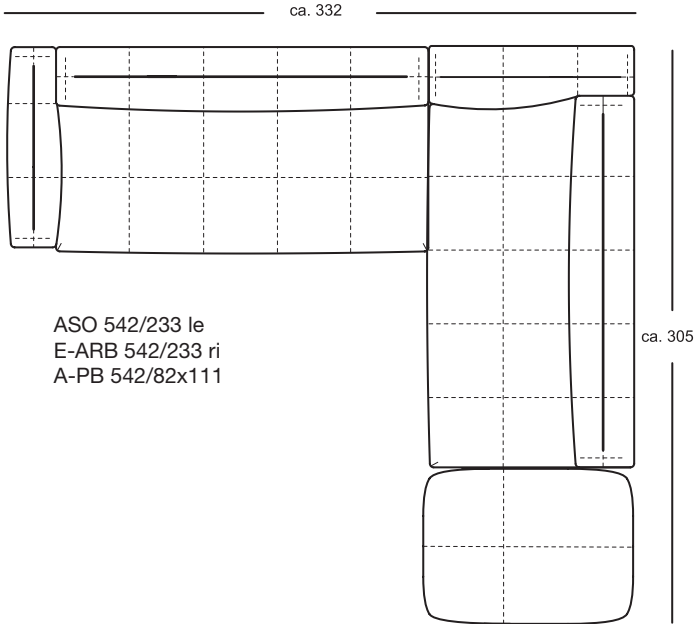

SOB 542/247
PB 542/121x82