

EN Halfway between a pendant and a ceiling lamp, Millimetro is composed of a very thin reflecting circular disk (1 mm thickness) and warm, enveloping light directed upward from below. The upper cap is attached to a stem that supports the metal disk with a mirror finish (diameter 50 or 85 cm). The LED light source, concealed behind the disk, provides a diffused, uniform glow. To respond to various installation requirements, it is possible to choose from four different lengths for the stem that connects the body of the lamp to the ceiling attachment (overall lamp height 23, 33, 53 and 73 cm).

IT A metà strada tra una lampada a sospensione e una a soffitto, Millimetro è composta da un sottilissimo disco circolare riflettente (1 mm di spessore) e da una luce calda e avvolgente che si irradia dal basso verso l'alto. Il rosone dell'apparecchio è collegato ad uno stelo che supporta il disco in metallo con superficie lappata a specchio (diametro 50 cm o 85 cm). La sorgente Led, celata dietro al disco, consente di proiettare una luce diffusa e omogenea. Inoltre, a seconda delle diverse esigenze installative, è possibile scegliere tra quattro lunghezze differenti dello stelo che collega il corpo lampada al rosone (altezza complessiva lampada 23, 33, 53 e 73 cm).

DE Millimetro positioniert sich exakt zwischen einer Hängeleuchte und einer Deckenleuchte. Die Leuchte besteht aus einer sehr dünnen, kreisförmigen, reflektierenden Scheibe (1 mm dick) und einem warmen, einhüllenden Licht, das von unten nach oben strahlt. Die Rosette des Geräts ist mit einem Schaft verbunden, der die Metallscheibe mit einer hochglanzgeläppten Oberfläche (Durchmesser 50 cm oder 85 cm) trägt. Die LED-Lichtquelle, die sich hinter der Scheibe verbirgt, ermöglicht die Projektion von diffusem und homogenem Licht. Darüber hinaus kann je nach den unterschiedlichen Installationsanforderungen zwischen vier verschiedenen Längen des Stiels, der den Leuchtenkörper mit dem Deckenbaldachin verbindet, gewählt werden (Gesamthöhe der Leuchte 23, 33, 53 und 73 cm).

FR À mi-chemin entre une lampe suspendue et une lampe à plafond, Millimetro se compose d'un disque réfléchissant circulaire très fin (1 mm d'épaisseur) et d'une lumière chaude et enveloppante qui rayonne du bas vers le haut. La rosace du luminaire est reliée à une tige qui supporte le disque métallique avec une surface avec rodage effet miroir (diamètre 50 cm ou 85 cm). L'ampoule LED, dissimulée derrière le disque, permet de projeter une lumière diffuse et homogène. En outre, en fonction des différentes exigences d'installation, il est possible de choisir entre quatre longueurs différentes de la tige reliant le corps de la lampe à la rosace (hauteur totale de la lampe 23, 33, 53 et 73 cm).

ES A medio camino entre una lámpara colgante y una de techo, Millimetro se compone de un disco circular reflectante muy fino (1 mm de espesor) y de una luz cálida y envolvente que se irradia de abajo hacia arriba. El florón del aparato está conectado a un vástago que soporta el disco de metal con superficie lapeada en espejo (diámetro 50 cm u 85 cm). La fuente LED, oculta detrás del disco, permite proyectar una luz difusa y homogénea. Además, dependiendo de las diferentes necesidades de instalación, es posible elegir entre cuatro longitudes diferentes del vástago que conecta el cuerpo de la lámpara al florón (altura total de la lámpara 23, 33, 53 y 73 cm).



## A11S50W

+ A11/2  
Ceiling rose

A11/1D dimmable push DALI  
A11/1T dimmable phase cut  
weight 3,2 Kg



## A11S50W + A11/2 - A11/1D - A11/1T

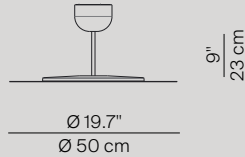

## A1185W + A11/2 - A11/1D - A11/1T

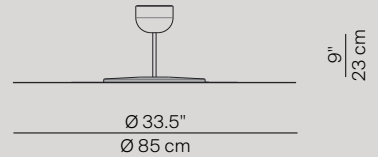

## A11S85W

+ A11/2  
Ceiling rose

A11/1D dimmable push DALI  
A11/1T dimmable phase cut  
weight 3 Kg



## A11S50W + A11/3 - A11/1D - A11/1T

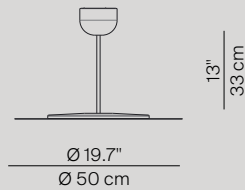

## A1185W + A11/3 - A11/1D - A11/1T

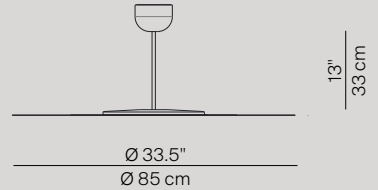

## A11S50W

+ A11/3  
Ceiling rose

A11/1D dimmable push DALI  
A11/1T dimmable phase cut  
weight 3,2 Kg



## A11S85W

+ A11/2  
Ceiling rose

A11/1D dimmable push DALI  
A11/1T dimmable phase cut  
weight 3 Kg



## A11S50W + A11/4 + A11/1D - A11/1T

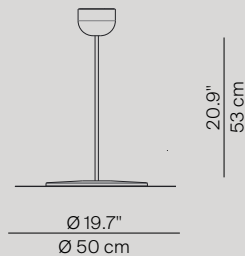

## A1185W + A11/4 + A11/1D - A11/1T



## A11S50W

+ A11/4  
Ceiling rose

A11/1D dimmable push DALI  
A11/1T dimmable phase cut  
weight 3,2 Kg



## A11S85W

+ A11/4  
Ceiling rose

A11/1D dimmable push DALI  
A11/1T dimmable phase cut  
weight 3 Kg



**A11S50W**  
**+ A11/5**  
**Ceiling rose**  
**A11/1D** dimmable push DALI  
**A11/1T** dimmable phase cut  
 weight 3,2 Kg

**A11S50W + A11/5 + A11/1D - A11/1T**

**A1185W + A11/5 + A11/1D - A11/1T**



**A11S85W**  
**+ A11/5**  
**Ceiling rose**  
**A11/1D** dimmable push DALI  
**A11/1T** dimmable phase cut  
 weight 3 Kg

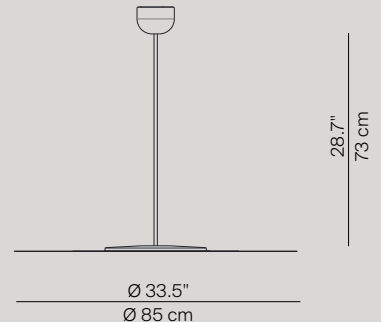
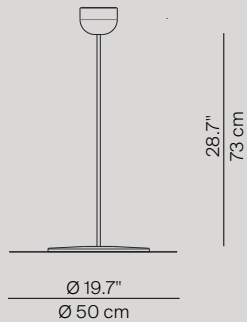

**A11A25W - A11A25**  
 weight 0,33 Kg

**A11A25W - A11A25**

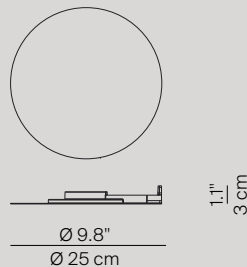

**Light source**

**A11S50W + A11/2-A11/3-A11/4-A11/5 + A11/1D**

LED module 39W, 2700K, CRI 90

**A11S50W + A11/2-A11/3-A11/4-A11/5 + A11/1T**

LED module 37W, 2700K, CRI 90

**A11A25W**

LED module 22W, 2700K, CRI 90

**A11A25**

LED module 22W, 3000K, CRI 90

**Materials**

Aluminium, steel and brass structure, polycarbonate diffuser

**Finishes**

**wall version**



White/  
mirror

**ceiling version**



Brass/  
mirror



Blue/  
mirror



Ø 85 cm



Ø 50 cm

